

Original Instructions

G695B

RIGHT ANGLE, DOUBLE ACTION
CHERRYLOCK[®] POWER TOOL



CHERRY[®]
AEROSPACE

1224 E. Warner Ave,
Santa Ana, Ca 92705
Tel: 1-714-545-5511
Fax: 1-714-850-6093
www.cherryaerospace.com

THE G695B DOUBLE ACTION RIGHT ANGLE RIVETER

TABLE OF CONTENTS

Description	3
Technical Specifications	3
Putting the Tool in Service	3
Warranty Information	3
General Operation Safety Warnings	4
Operating Instructions	5
Fastener / Pulling Head Selection	5
Installing H690 pulling head	5
Pulling Head Adjustment	5
Lock ring Anvil Setting Adjustment	6
Shift Point Setting	6
Riveter Repair and Maintenance	6
Tools and Service Kits Needed	7
Service Procedure	7
Head Cylinder Subassembly	7
Power Handle Subassembly	7
Air Valve Subassembly	7
Component List	8
Exploded View	9
Priming the Hydraulic System	10
Recommended Hydraulic Fluids	10
Fluid Handling Safety	10
Bleeding Instructions	10
Troubleshooting Guide	11

USATCO U.S. Air Tool Company, Inc.

Info@usatco.com

Eastern Division60 Fleetwood Ct., Ronkonkoma, NY 11779-6907 tel: (631) 471-3300 fax: (631) 471-3308

Western Division1219 W. Mahalo Place, Rancho Dominguez, CA 90220-5446 tel: (310) 632-5400 fax: (310) 632-3900

LOCTITE® is a registered trademark of Henkel Corporation
DEXRON® is a registered trademark of GM Corporation.
PARKER® is a trademark of Parker Hannifin Corporation
LUBRRIPLATE® is a trademark of Fiske Brothers Refining Co.

DESCRIPTION

The Cherry® G695B riveter is a compact, right angle riveter designed for high productivity, reliable installation of the short grip double action

Cherrylock® fasteners (NAS1738 / NAS1739 bulb and NAS1398 / NAS1399 wiredraw types).

The pulling heads (H690 Series) are not furnished with this tool and must be ordered separately.

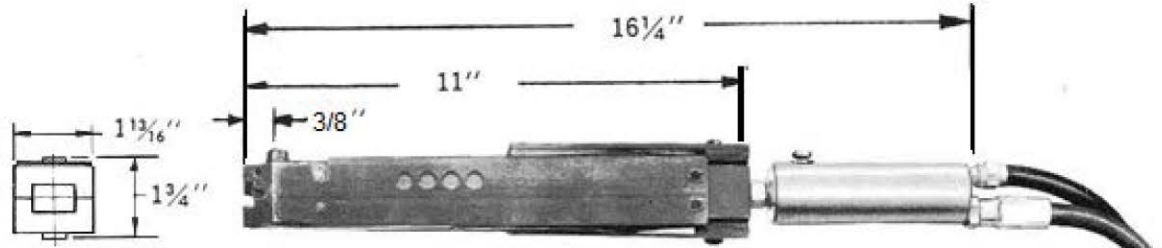

TECHNICAL SPECIFICATIONS

Cherry® Aerospace (CHERRY®) policy is one of continuous development.

Specifications shown in this document may be subject to change which may be introduced after publication. For the latest information always consult CHERRY®.

- AIR PRESSURE 90 to 110 PSI (6.2 to 7.6 bar)
- STROKE 5/8 inch (15.8 mm)
- PULLING-FORCE: 2000 lbs @ 90 psi
 (8.9 kN @ 6.2 bar)

PUTTING THE TOOL IN SERVICE

Connect the tool to a dedicated line of clean air equipped with a pressure regulator.

If necessary, a preset inline pressure regulator may be purchased and mounted at the air inlet of the riveter (P1505, sold separately).













USATCO U.S. Air Tool Company, Inc.

Info@usatco.com

Eastern Division60 Fleetwood Ct., Ronkonkoma, NY 11779-6907 tel: (631) 471-3300 fax: (631) 471-3308
 Western Division1219 W. Mahalo Place, Rancho Dominguez, CA 90220-5446 tel: (310) 632-5400 fax: (310) 632-3900

SAFETY WARNINGS

	<ul style="list-style-type: none"> • Wear proper PPE (<i>Personal Protection equipment</i>) when operating, servicing or repairing this tool
	<ul style="list-style-type: none"> • Read Manual; operators must be trained in safety and correct tool operation
	<ul style="list-style-type: none"> • Service and repairs shall be performed only by trained personnel.
	<ul style="list-style-type: none"> • Do not pull rivet in the air or directed at any person.
	<ul style="list-style-type: none"> • Do not use the tool with a damaged or missing stem deflector
	<ul style="list-style-type: none"> • Make sure that the air muffler is not obstructed and is directed away from people.
	<ul style="list-style-type: none"> • Do not exceed the recommended air pressure. To ensure safety, use the pre-set air pressure regulator P/N P1505.
	<ul style="list-style-type: none"> • Make sure to disconnect from the air supply before service or repair.
	<ul style="list-style-type: none"> • Wash thoroughly after handling hydraulic fluid.
	<ul style="list-style-type: none"> • Unauthorized modifications, including using substitute components will void warranty and shall be at the customer's entire responsibility.
	<ul style="list-style-type: none"> • Do not use any substitutions as they will impact the tool safety and reliability life.

OPERATING INSTRUCTIONS



Before using the tool:

⚠ CAUTION ⚠

- Read the tool manual instructions; before first using the tool.
- Read and comply to all safety instructions given in this document in addition to the general safety rules applicable
- Make sure the tool is connected to an air source operating within the recommended pressure range
- Before installing the permanent fasteners, make sure that the structure is properly clamped with temporary fasteners
- Make sure that the correct pulling head is selected for the fastener to be installed and that the tool is in good working condition

Installing Fasteners: Place the fastener into the prepared hole then place the pulling head over its stem and depress the trigger.

PULLING HEAD SELECTION FOR BLIND FASTENERS

- The lists given below are for reference only; for more up to date and detailed information, please check on the Cherry Aerospace webpage as following: [Installation Tooling Manuals](#)(links to current tool manuals) and [Product Expert](#) (interactive database for tool recommendations)

BULB TYPE CHERRYLOCK FASTENERS (NAS1738 & NAS1739)					
RIVET DETAILS	MATERIAL	ALUMINUM		MONEL	
	HEAD STYLE	UNIVERSAL	FLUSH	UNIVERSAL	FLUSH
	BASE PART NUMBER	CR22239	CR22238	CR2539	CR2538
PULLING HEAD PART NUMBER	RIVET DIA. CODE	THIS TOOL INSTALLS UP TO THE FOLLOWING GRIP CODE			
H690-4	-4	ALL GRIPS	ALL GRIPS	ALL GRIPS	ALL GRIPS
H690-5	-5	ALL GRIPS	ALL GRIPS	ALL GRIPS	ALL GRIPS
H690-6	-6	-	-	-	-

WIREDRAW TYPE CHERRYLOCK FASTENERS (NAS1398 & NAS1399)							
RIVET DETAILS	MATERIAL	ALUMINUM		MONEL		STAINLESS STEEL	
	HEAD STYLE	UNIVERSAL	FLUSH	UNIVERSAL	FLUSH	UNIVERSAL	FLUSH
	BASE PART NUMBER	CR2163	CR2162			CR2643	CR2642
PULLING HEAD PART NUMBER	RIVET DIA. CODE	THIS TOOL INSTALLS UP TO THE FOLLOWING GRIP CODE					
H690-4	-4	-04	-04	-04	-04	-04	-04
H690-5	-5	-04	-04	-04	-04	-04	-04
H690-6	-6	-04	-04	-04	-04		
H690-8	-8	-04	-04				

INSTALLING THE PULLING HEAD ON RIVETER

- Place anvil (B) into nose piece (C)
- Pry the bottom leaf spring open, with the help of a flat screwdriver, far enough to insert the anvil and nose assembly. Release the leaf spring and allow it to snap over the nose assy.
- Remove the set screw (20) and thread the jaw holder assembly (A) into upper frame (using flat wrench 690A62 included with tool) to about 1/16" protrusion behind the upper frame.
- Thread screw (20) back in without tightening; the pulling head must be adjusted following the directions below.
- In case an extension nose piece is being used (for example P/N H690-4C-15/16") there is an additional part (ring, shown in dotted line). This ring must be placed on top of the anvil (B) / nose piece assembly before being placed into the leaf spring.
In this case, is advisable in this case to loosen the screws holding the leaf spring rather than forcing it open.

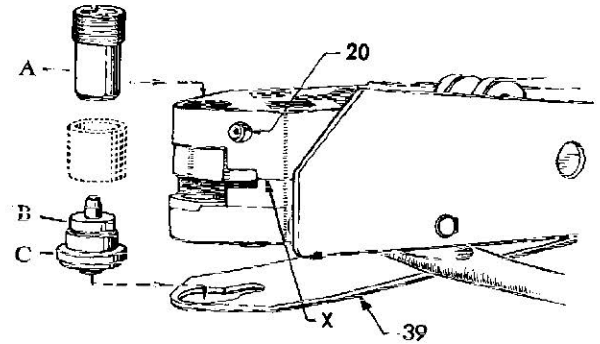

PULLING HEAD ADJUSTMENT

- Prior to installing fasteners, the pulling head must be setup using the setup gages provided with the riveter. The gages are color coded as following:
 - Green for the -4 diameter, (P/N 628-4)
 - Red for the -5 diameter (P/N 628-5)
 - Blue for the -6 diameter (P/N 628-6)
 - No color for the -8 diameter (P/N 628-8)

LOCKRING ANVIL SETTING ADJUSTMENT

Note: All the item numbers refer to the exploded view from page 10.

1. Insert the short end of the setup gage into the nosepiece (C).
2. Loosen the Jam Nut (item 29) so set screw (item 28) can be adjusted.
3. Thread the set screw (item 28) in or out until top of the gage is flush with the gaging surface
4. Tighten the Jam Nut (item 29) while holding the Set Screw (item 28) to prevent it from rotating.

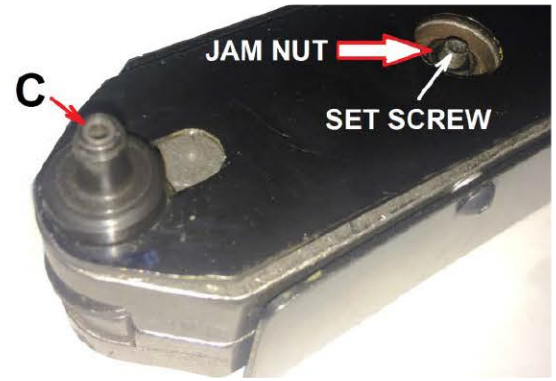

SHIFT POINT SETTING

Before starting this set-up, make sure that the set screw (20) is loose.

1. Select the appropriate diameter gage and push the long, serrated end into the nosepiece (C); if the gage falls freely,
2. Unthread (turn counter-clockwise) the jaw holder (A) with tool 690A62, until the gage pin get stuck inside the nosepiece
3. Loosen the grip slightly by threading the jaw holder (A) in (turn clockwise) about a quarter turn.
4. Tighten the set screw (20).

To verify setup, install fasteners in a test plate; the fastener stems should break relatively flush with the top of the rivet (see applicable procurement specifications). If high or low stem protrusion is observed, loosen the set screw (20) and turn the jaw assembly holder (A) one-quarter of a turn at a time, in either direction, until desired flushness is obtained. The position of the anvil (see above procedure) may also need to be fine-tuned.

RIVETER REPAIR AND MAINTENANCE



This riveter has been manufactured to give maximum service with minimum care. In order to keep the tools in optimum operating condition, it is advisable to set-up a Preventive Maintenance check list including, at a minimum, the following:

- Visually inspect the tool to make sure it is in good working condition and there are no fluid leaks
- Make sure the tool is bled regularly (page 12)
- Check the service sticker due date; service the tools on a regular basis.

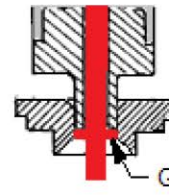

UNIVERSAL HEAD
(Ex: H690-5U)

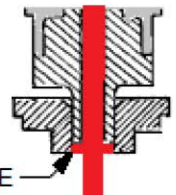

FLUSH HEAD
(Ex: H690-5C)

Should repair or service be necessary, follow the instructions given below.

⚠ CAUTION ⚠

- Read the tool manual instructions; it is advised that repair is conducted only by properly trained personnel.
- Make sure the air is disconnected.
- Protect the sealing surfaces to avoid damage.

Tools and Service Kits Needed

- Make sure that the proper service kit (*ordered separately*) and tools are available.
 - **SERVICE KIT:** G695KS –contains Springs, Seals, O-Rings and Back-up Rings
 - **TOOLS:** G85KT – tool kit and a Needle Nose Pair of Pliers



SERVICE PROCEDURE

HEAD SUBASSEMBLY

Disassembly Instructions:

- Remove the bleed screw (38) and drain the fluid.
- Loosen set screw (20) and remove the pulling head.
- Remove the screws (26) and the sides (17) and push out the pins (23 and 41).
This will allow frames (19 and 40) to fall free and rocker arm (24) may then be lifted out.
- Remove the screws (12) from top and bottom of the cylinder then remove the springs, spacers, and limit bars (13, 14, 15, 16 & 39)
- Unscrew the cap (9) and pull on the cam (11); remove the set screw (10) first should removing the cam from the piston (4) be necessary

Assembly Instructions:

- Build the cylinder assembly first; assemble items (1) through (11) making sure the set screw (10) is tight against piston rod (4).
- Place frames (19 and 40) one on top of the other; they should fit together with no warping.
- Install rollers (18) in upper frame (19), using pin (23).
- Install bearings (22) in rocker arm (24), using pin (21) and install rollers (18) in lower frame (40), using pins (30).
- Place sleeve (25) in the large hole of the lower frame (40).
- Install the rocker arm (24) in the lower frame (40), using pin (23).
- Thread the adjustment-screw (28) in through the lower frame (40) and secure it with jam nut (29).
- Slide the lower frame (40) over cylinder assembly (36) making sure that cam (11) is in the correct position with the flat section at the bottom as shown in sketch. Insert pin (41) through frame and through bottom hole in cylinder (36).
- Slide the upper frame (19) over the cylinder assembly (36) and hold in place with pin (41).
- Place sides (17) over the frames (19 and 40) and secure with screws (26), using washers (27) over the front two screws, between the sides and the frames, for clearance.
- Attach leaf springs (39 and 16), spacer (14), and limit bar (13) starting with lower frame, using the screws (12).
Note: Leaf spring (39) should be all the way forward and aligned with large hole in lower frame. Repeat this operation with upper frame. Make sure that all hoses and fittings are connected properly as shown in the exploded view.

POWER HANDLE SUBASSEMBLY

Disassembly Instructions:

- Remove the Manifold (49) and set it aside
- Drain all the fluid, then turn up-side down and remove the screws holding the bottom cover (87);
- Push the power piston all the way down, remove the cotter pin (82) and unthread the locknut (81) and then remove the air piston (80) by using wrench 530A86 and a 9/16" socket wrench; hold the top of the piston with tool 530A86 to prevent it from turning. When completely unthreaded, insert the thread end of too 530A88 into the bottom of air piston (80) and using it as a handle, pull the piston out
- Remove packing plug (77) with the help of wrench 530A83 and a 1-1/16" socket wrench.
- Tap the power cylinder (70) from the top (use tool 530A88); when loosened, it will fall through the bottom of the handle.
- Remove all the seals and inspect all components for wear. Replace all seals and worn components

Assembly Instructions:

- The re-assembly sequence is the opposite of disassembly; to prevent damage to piston threads; suggested tightening torque for the locknut (37) between 50 and 59 in-lb (5.65 and 6.67 N-m).
- After service, the riveter must be primed and bled (page 12)

AIR VALVE SUBASSEMBLY

Disassembly Instructions:

- Remove retaining ring (69) and muffler (68).
- Pull out the valve plug (67) and the Valve Spool (65) with the help of extractor P1178;
- Dislodge and pull the spring (63) out using needle-nose pliers
- In the unlikely event that you want to pull the Valve Sleeve (62), use the tool 837B530 (internal expansion collet).

Assemble Instructions:

- Replace all O-Rings and apply an O-ring lubricant (Parker® silicone lube or equivalent).
- To re-assemble, reverse the procedure given above; snap the Spring (63) into its groove with the help of tool 836B530

G695B – COMPONENT LIST

REF	PART	DESCRIPTION	QTY.
1	P604	O-Ring	1
2	P603	Back-Up Ring	1
3	P528	O-Ring	1
4	690A157	Piston	1
5	690A8	Piston Spring	1
6	690A26	Stop	1
7	P921	O-Ring	1
8	P690	O-Ring	1
9	690A29	Cap	1
10	P842	Set Screw	1
11	690A105	Cam	1
12	P710	Button Head. Screw	4
13	690A60	Limit Bar	2
14	690A61	Spacer	2
15	690A25	Leaf Spring	1
16	690A24	Leaf Spring	2
17	690B114	Side	2
18	690A156	Roller	4
19	690C103	Upper Frame	1
20	P924	Soc. Hd. Set Screw	1
21	690A23	Rear Bearing Pin	1
22	P547	Roller Bearing	2
23	690A121	Upper Bearing Pin	2
24	690C104	Rocker Arm	1
25	690A30	Sleeve	1
26	P413	Soc. Hd. Screw	4
27	P366	Washer	2
28	P402	Set Screw	1
29	P923	Jam Nut	1
30	690A122	Lower Bearing Pin	2
33	690A 113	Handle	1
34	703A33	Trigger Assembly	1
35	P223	O-Ring	1
36	690A158	Cylinder Assembly	1
37	P572	Stat-O-Seal	1
38	P573	Button Hd. Soc. Screw	1
39	690B28	Leaf Spring	1
40	690C102	Lower Frame	1
41	690A127	Frame Pin	2
42	530A123-8	Oil Hose Assembly	1
43	530A119-8	Air Hose Assembly	1
44	P579	Steel Bushing	2
45	P456	Hose Fitting	2

REF	PART	DESCRIPTION	QTY.	
46	P463	Pipe Plug Dryseal	1	
47	P225	Button Hd. Soc. Screw	1	
48	P670	Stat-O-Seal	1	
49	680A37-3	Manifold Assembly	1	
52	530A60	Power Piston & Rod Assembly	1	
	50	P209	Back-Up Ring	2
	51	P216	Quad Ring	1
53	P194	O-Ring	1	
54	530B8	Gasket	1	
55	530A113	Button Head. Cap Screw	1	
56	530A146	Handle	1	
57	P64	Socket Head. Cap Screw	6	
58	530A35	Swivel Bolt	1	
59	P195	O-Ring	2	
60	530A34	Swivel	1	
61	P848	O-Ring	4	
62	530B179	Valve Sleeve	1	
63	590A178	Spring	1	
64	P701	O-Ring	3	
65	530B143	Spool Valve	1	
66	P244	O-Ring	2	
67	530A144	Valve Plug	1	
68	530A145	Muffler	1	
69	P699	Retaining Ring	1	
70	530A13B	Power Cylinder	1	
71	P218	Quad Ring	2	
72	P204	Retaining Ring	2	
73	530A21-3	Washer	2	
74	P213	Back-Up Ring	4	
75	P215	Quad Ring	2	
76	P196	O-Ring	1	
77	530B14	Packing Plug	1	
78	P214	Back-Up Ring	2	
79	P222	Quad Ring	1	
80	530B15	Air Piston	1	
81	P302	Slotted Nut	1	
82	P301	Cotter Pin	1	
83	P537	Retaining Ring	1	
84	530B92	Bonded Cushion	1	
85	P197	O-Ring	1	
86	530C141	Handle Base	1	
87	P700	Flat Head Socket Cap Screw	6	

G695B – Exploded View

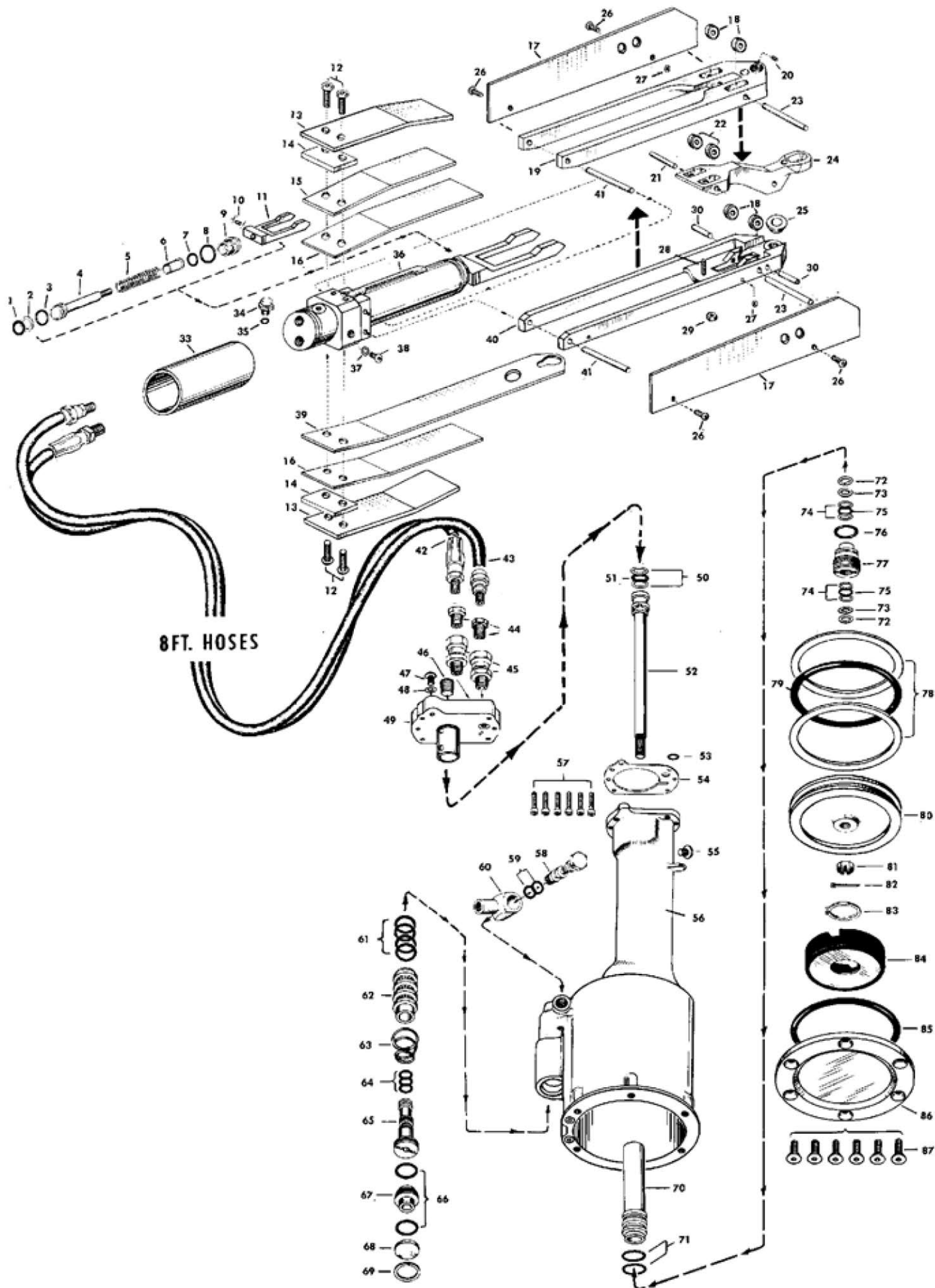

PRIMING THE HYDRAULIC SYSTEM



RECOMMENDED HYDRAULIC FLUID

The riveter is supplied with **Dexron® III ATF type "A"**.

<i>Specific gravity:</i>	0.863
<i>Weight per gallon:</i>	7.18 lbs.
<i>Open flash point:</i>	>200°C (392°F)

COMPATIBLE ALTERNATE FLUIDS

- **Automatic Transmission Fluids:** DEXRON IV, MERCON, Allison C4 or equivalent.
- **Hydraulic Fluids:** Hyspin® VG32, Aeroshell fluid 4

⚠ CAUTION ⚠

- **DO NOT MIX DIFFERENT TYPES OF HYDRAULIC OILS AND TRANSMISSION; HYDRAULIC AND TRANSMISSION FLUIDS ARE NOT COMPATIBLE DIFFERENT TYPES OF FLUIDS MAY NOT BE COMPATIBLE WITH EACH OTHER.**
- **PHYSICAL PROPERTIES AND MATERIAL SAFETY DATA SHEETS FOR DIFFERENT FLUIDS MAY DIFFER FROM THE ONE GIVEN BELOW, BUT THE SAFETY INFORMATION STILL APPLIES; CHECK WITH THE FLUID MANUFACTURER FOR ADDITIONAL MSDS AND SPECIFIC PROPERTIES.**

FLUID HANDLING SAFETY

 ENVIRONMENTAL		<ul style="list-style-type: none"> • Waste Disposal in accordance with the applicable regulations
		<ul style="list-style-type: none"> • Soak up spills with diatomaceous earth or other inert materials. • Keep from drains, sewers and water courses. • Filter and recycle used fluid; otherwise store and dispose of according to the applicable regulations.
 HANDLING	 Approved Personal Protective Equipment must be worn	<ul style="list-style-type: none"> • Eye protection is required. • Protective gloves, chemically resistant boots and apron are recommended.
 FIRST AID		<ul style="list-style-type: none"> • Flush eyes thoroughly with water. • If irritation develops, consult a physician.
		<ul style="list-style-type: none"> • To prevent inhalation, use in well-ventilated area. • Short term exposure should pose no adverse health effects. • If inhalation occurs, remove the affected person from the contaminated area and apply artificial respiration if needed.
		<ul style="list-style-type: none"> • DO NOT INDUCE VOMITING. • Seek medical attention immediately.
		In case of skin contamination: <ul style="list-style-type: none"> • Wash thoroughly with soap and water as soon as possible. • Brief skin contact requires no immediate attention. • If irritation develops, consult a physician.
 COMBUSTIBILITY		<ul style="list-style-type: none"> • It is slightly combustible when heated above flash point. • It will release flammable vapors which can burn in open or be explosive in confined spaces if exposed to source of ignition. • Do not store near open flames or other sources of ignition.
		<ul style="list-style-type: none"> • In case of fire, use only suitable extinguishing media: CO2, dry powder, foam or water fog. • CAUTION: DO NOT USE WATER JETS.

PRIMING AND BLEEDING THE TOOL

After service, the riveter must be primed with hydraulic fluid before re-assembling the head cylinder.

- Stand the base upright and fill the base handle (56) with fluid up to the top then assemble and tighten the manifold.
- Stand the base upright with the hoses and head assembly above it and connect to an airline. Caution: The tool will automatically trigger, so hold the head assembly firmly.
- Remove the screws (38) and (47) from cylinder (36) and manifold (49).
- Using a pressurized fluid source, circulate fluid until the it drains smoothly with no air bubbles out of the bleed hole (where screw 38 was)
- Thread the screws back in and cycle the tool a few times to make sure it functions properly.
- Redo this procedure if necessary to remove all the air pockets from the hydraulic fluid.

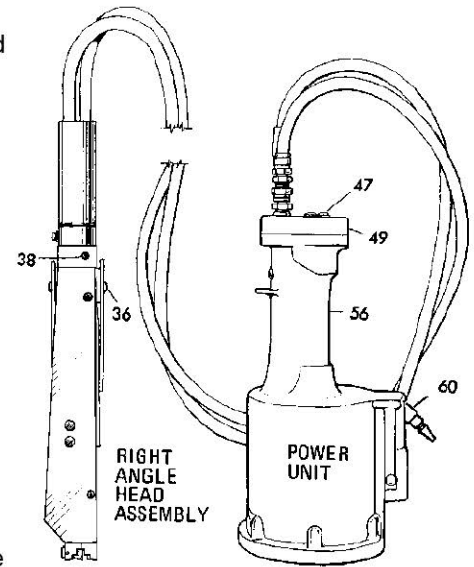

BLEEDING INSTRUCTIONS

This operation should be done as part of regular tool maintenance in order to replenish the hydraulic fluid and remove the air bubbles from the hydraulic fluid.

What is needed: an 1/8" Hex Key; 700A77 Bleed Bottle

- Place the hand held unit over an oil drip pan and remove the side Screw (38);
- Attach the Bleeder Bottle 700A77 and place the hand held unit in a vise making sure that the bleeder bottle is upside down and it is the highest point of the system.
- Cycle several times; air bubbles from the system will be pushed up into bleed bottle, being replaced by hydraulic fluid. Continue cycling until no more air bubbles are released into the bottle.
- When done, carefully remove the bleed bottle and replace with Screw (38).
- Test for correct function; re-set if necessary.



TROUBLESHOOTING GUIDE

Should the riveter not operate properly,

1. Check that the tool is connected to an airline and the air pressure is within the recommended limits..
2. Bleed the system to eliminate air and replenish fluid.
3. Check for oil leakage.
 - a) Leakage around the cap screw (38) indicates that the screw is loose or the gasket (37) needs replacing.
 - b) Leakage through the by-pass hole at the base of the handle (56) indicate that the O-Rings (75) are worn or damaged.
4. Operate the trigger repeatedly to determine that it is working properly; this can be done by listening to the tool as the trigger is depressed and released. If the valve is working properly the air piston (80) and power piston (52) can be heard traveling inside the tool.
5. Check the piston stroke. If the tool is short of stroke, it may need to be serviced or at least bled properly.
6. Make sure the set screw (20) is tightened; if it gets lose, the jaw holder setting drifts during operation incapable of holding setup.

If the riveter still fails to operate properly, it may need to be serviced; we recommend contacting one of our authorized US or international repair centers (<http://cherryaerospace.com/contacts/distributors#tool-repair-us> or

<http://cherryaerospace.com/contacts/distributors#tool-repair-intl>)

WARRANTY

Seller warrants the goods conform to applicable specifications and drawings and will be manufactured and inspected according to generally accepted practices of companies manufacturing industrial or aerospace fasteners. In the event of any breach of the foregoing warranty, Buyer's sole remedy shall be to return defective goods (after receiving authorization from Seller) for replacement or refund of the purchase price, at the Seller's option. Seller agrees to any freight costs in connection with the return of any defective goods, but any costs relating to removal of the defective or nonconforming goods or installation of replacement goods shall be Buyer's responsibility. SELLER'S WARRANTY DOES NOT APPLY WHEN ANY PHYSICAL OR CHEMICAL CHANGE IN THE FORM OF THE PRODUCT IS MADE BY BUYER.

THE FOREGOING EXPRESS WARRANTY AND REMEDY ARE EXCLUSIVE AND ARE IN LIEU OF ALL OTHER WARRANTIES AND REMEDIES; ANY IMPLIED WARRANTY AS TO QUALITY, FITNESS FOR PURPOSE, OR MERCHANTABILITY IS HEREBY SPECIFICALLY DISCLAIMED AND EXCLUDED BY SELLER. THIS WARRANTY IS VOID IF SELLER IS NOT NOTIFIED IN WRITING OF ANY REJECTION OF THE GOODS WITHIN ONE (1) YEAR AFTER INITIAL USE BY BUYER OF ANY POWER RIVETER OR NINETY (90) DAYS AFTER INITIAL USE OF ANY OTHER PRODUCT.

Seller shall not be liable under any circumstances for incidental, special or consequential damages arising in whole or in part from any breach by Seller, AND SUCH INCIDENTAL, SPECIAL, OR CONSEQUENTIAL DAMAGES ARE HEREBY EXPRESSLY EXCLUDED.

For more information please contact our Technical Services Department at Tel. 714-850-6022