

USATCO Precision Cast Bucking Bars

Product Details

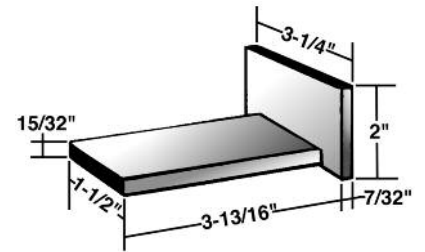

Part No.	Weight
08-1023	1.25 lbs (0.6 kgs)

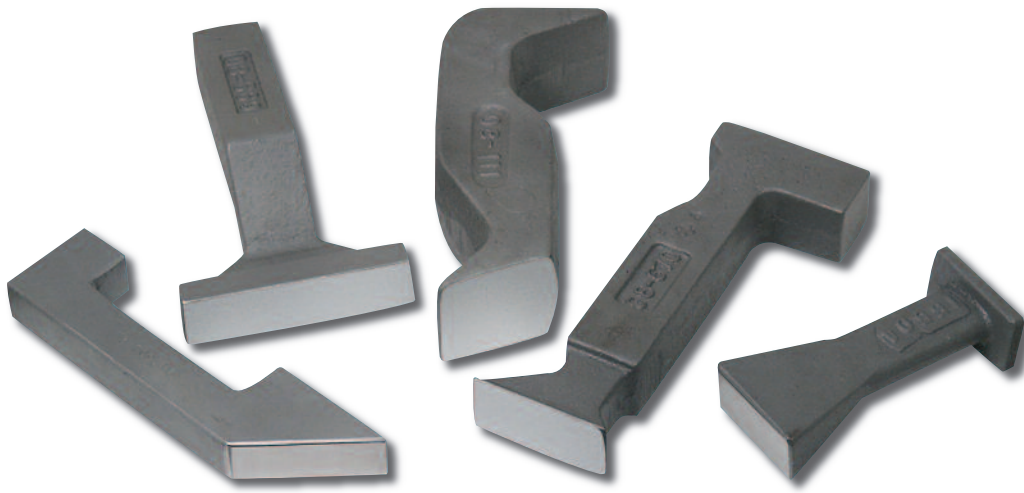
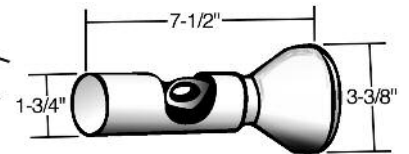
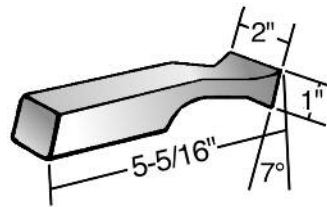
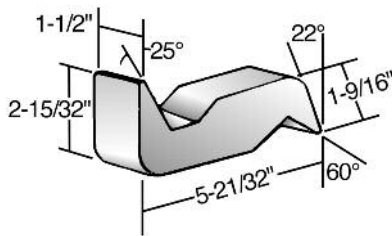
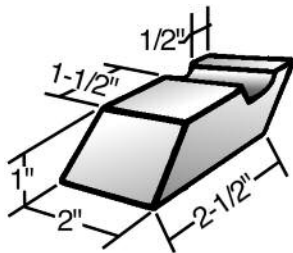

Part No.	Weight
08-1090	1.4 lbs (0.6 kgs)

Part No.	Weight
08-111	3.0 lbs (1.4 kgs)

Part No.	Weight
08-112	1.5 lbs (0.7 kgs)

Part No.	Weight
08-603	6.5 lbs (2.9 kgs)

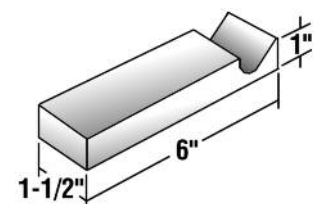
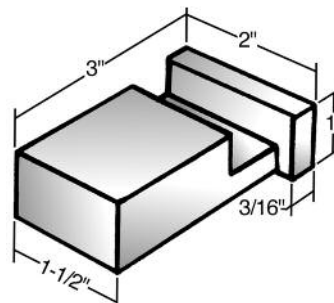
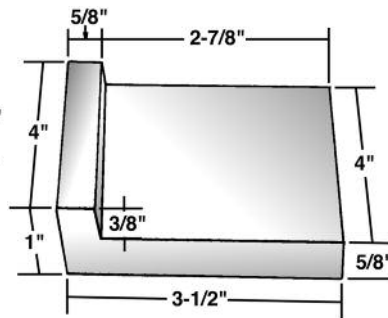
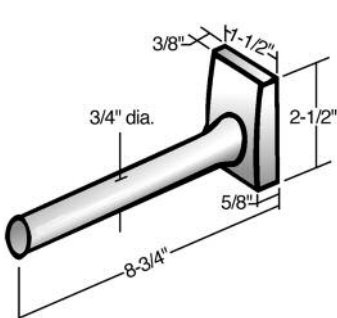

Part No.	Weight
08-604A	2.0 lbs (0.9 kgs)

Part No.	Weight
08-607	2.5 lbs (1.1 kgs)

Part No.	Weight
08-619	1.3 lbs (0.6 kgs)

Part No.	Weight
08-622	2.5 lbs (1.1 kgs)

Selection continues on next page...

Toll Free Nationwide & Canada: **800-645-8180**

USATCO\U.S. AIR TOOL COMPANY, INC. www.USATCO.com NEW YORK • CALIFORNIA

Rev1216

USATCO Precision Cast Bucking Bars

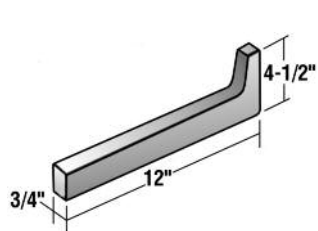

Part No.	Weight
08-625	6.5 lbs (2.9 kgs)

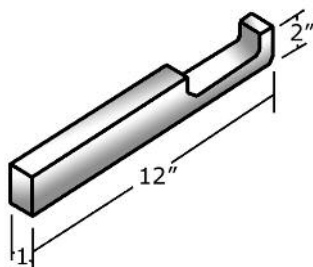

Part No.	Weight
08-626	6.0 lbs (2.7 kgs)

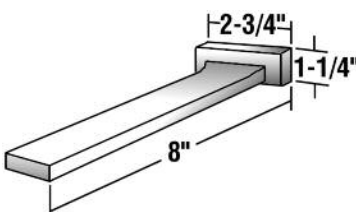

Part No.	Weight
08-630	1.5 lbs (0.7 kgs)

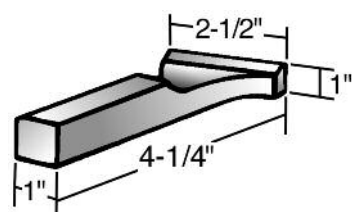

Part No.	Weight
08-633	1.25 lbs (0.6 kgs)

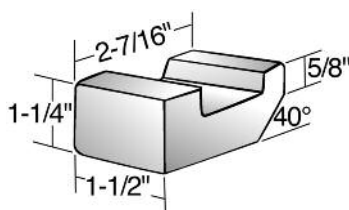

Part No.	Weight
08-634	1.2 lbs (0.6 kgs)

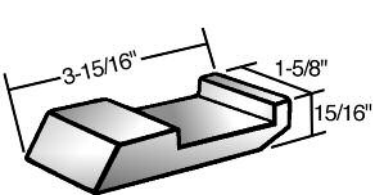

Part No.	Weight
08-638	1.25 lbs (0.6 kgs)

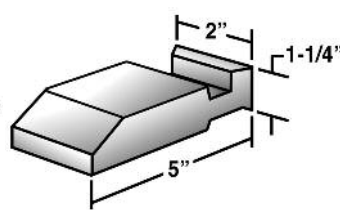

Part No.	Weight
08-640	3.0 lbs (1.4 kgs)

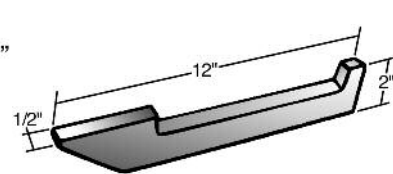

Part No.	Weight
08-646	2.25 lbs (1.0 kgs)

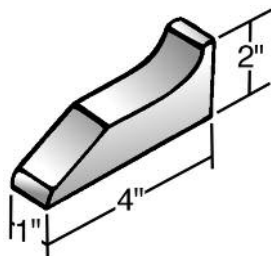

Part No.	Weight
08-647	1.5 lbs (0.7 kgs)

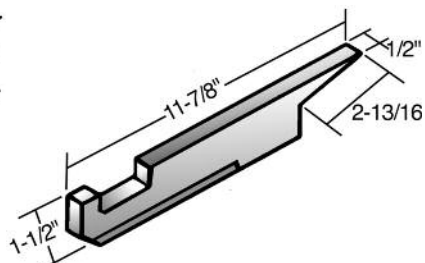

Part No.	Weight
08-649	2.0 lbs (0.9 kgs)

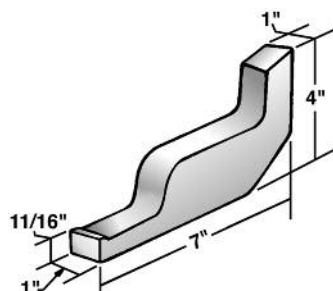

Part No.	Weight
08-653	3.0 lbs (1.4 kgs)

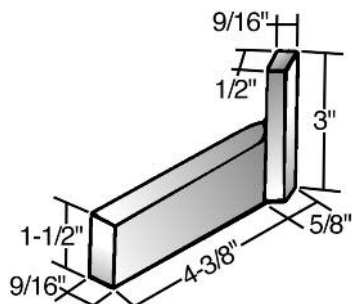

Part No.	Weight
08-656	1.0 lbs (0.45 kgs)

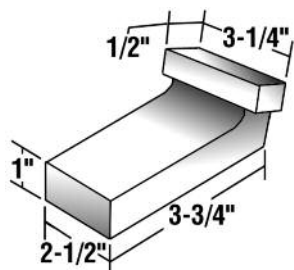

Part No.	Weight
08-658	3.75 lbs (1.7 kgs)

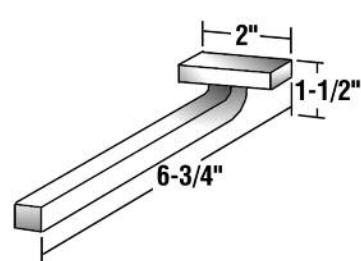

Part No.	Weight
08-662	0.75 lbs (0.3 kgs)

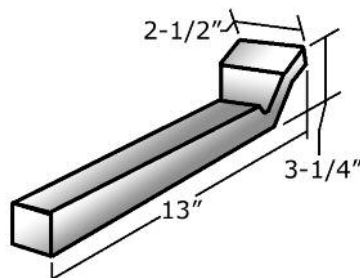

Part No.	Weight
08-666	9.25 lbs (4.2 kgs)

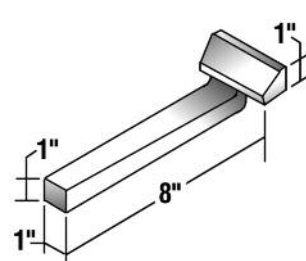

Part No.	Weight
08-668	3.0 lbs (1.4 kgs)

Selection continues on next page...

USATCO U.S. Air Tool Company, Inc.

Eastern Division60 Fleetwood Ct., Ronkonkoma, NY 11779-6907 tel: (631) 471-3300 fax: (631) 471-3308
 Western Division1219 W. Mahalo Place, Rancho Dominguez, CA 90220-5446 tel: (310) 632-5400 fax: (310) 632-3900

USATCO Precision Cast Bucking Bars

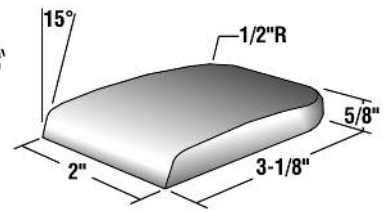
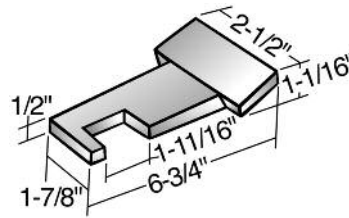
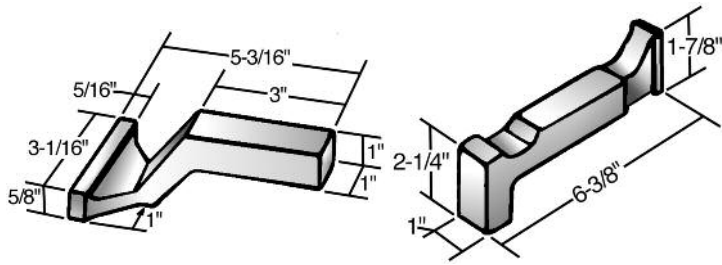

Part No.	Weight
08-669	1.5 lbs (0.7 kgs)

Part No.	Weight
08-670	2.0 lbs (0.9 kgs)

Part No.	Weight
08-671	2.25 lbs (1.0 kgs)

Part No.	Weight
08-6721A	1.0 lbs (0.45 kgs)

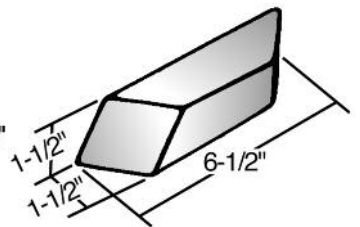
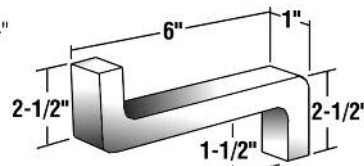
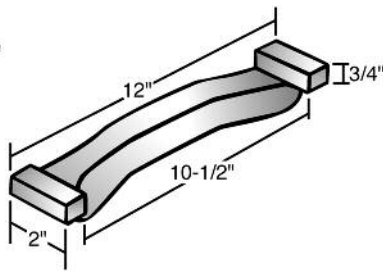
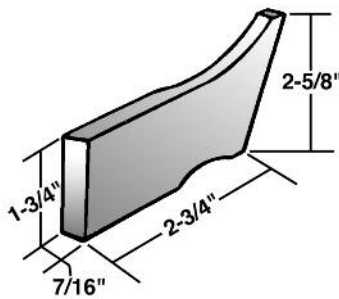

Part No.	Weight
08-676	0.75 lbs (0.34 kgs)

Part No.	Weight
08-686	4.25 lbs (1.9 kgs)

Part No.	Weight
08-690	2.5 lbs (1.1 kgs)

Part No.	Weight
08-692	3.0 lbs (1.4 kgs)

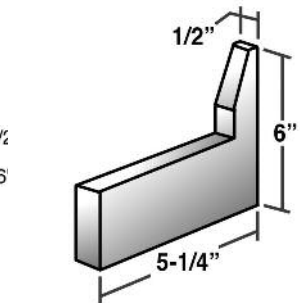
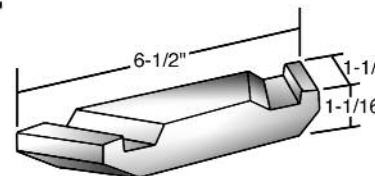
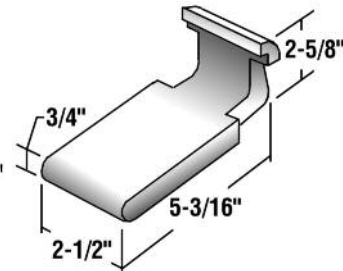
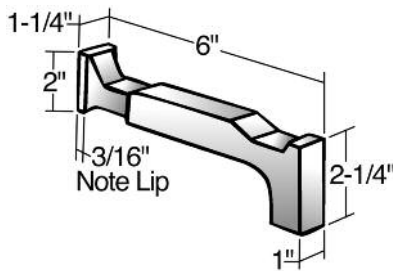

Part No.	Weight
08-694	2.0 lbs (0.9 kgs)

Part No.	Weight
08-701	2.75 lbs (1.2 kgs)

Part No.	Weight
08-702	2.0 lbs (0.9 kgs)

Part No.	Weight
08-716	2.0 lbs (0.9 kgs)

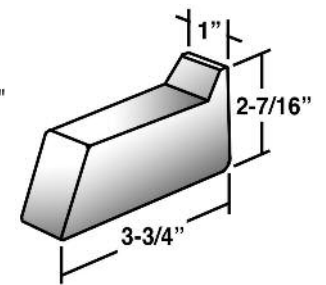
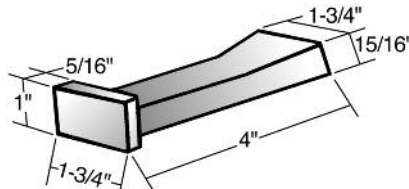
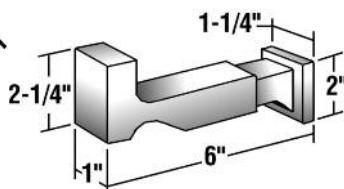
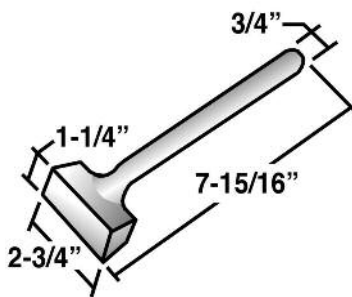

Part No.	Weight
08-718	1.5 lbs (0.68 kgs)

Part No.	Weight
08-719	2.0 lbs (0.9 kgs)

Part No.	Weight
08-720	0.75 lbs (0.34 kgs)

Part No.	Weight
08-721	1.75 lbs (0.79 kgs)

Selection continues on next page...

USATCO U.S. Air Tool Company, Inc.

Eastern Division60 Fleetwood Ct., Ronkonkoma, NY 11779-6907 tel: (631) 471-3300 fax: (631) 471-3308
 Western Division1219 W. Mahalo Place, Rancho Dominguez, CA 90220-5446 tel: (310) 632-5400 fax: (310) 632-3900

USATCO Precision Cast Bucking Bars

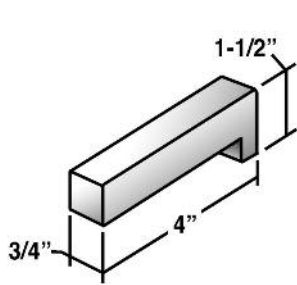

Part No.	Weight
08-727	1.0 lbs (0.45 kgs)

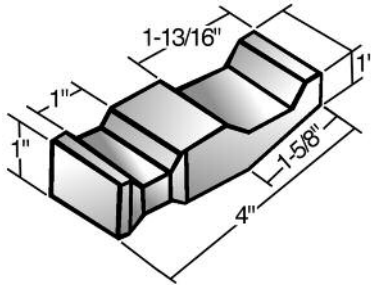

Part No.	Weight
08-730	1.25 lbs (0.6 kgs)

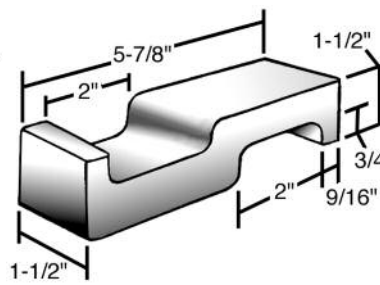

Part No.	Weight
08-736	2.3 lbs (1.0 kgs)

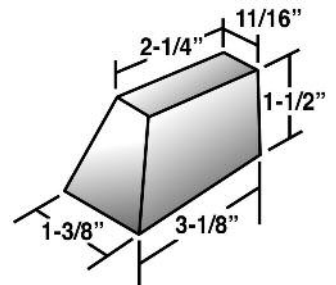

Part No.	Weight
08-750G-1	1.3 lbs (0.59 kgs)

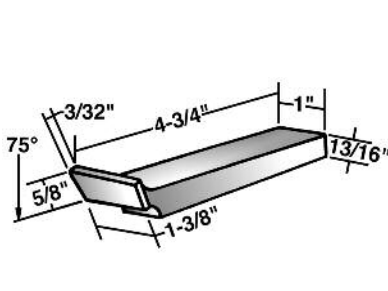

Part No.	Weight
08-750K-1	1.125 lbs (0.5 kgs)

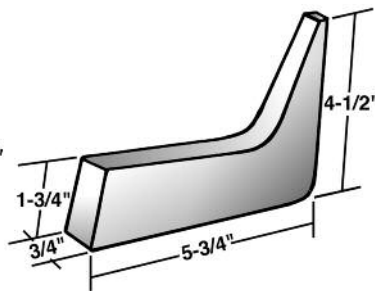

Part No.	Weight
08-750N-1	2.25 lbs (1.0 kgs)

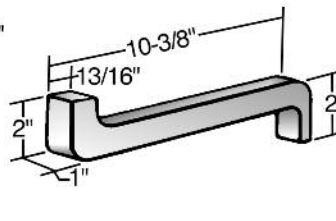

Part No.	Weight
08-751	3.25 lbs (1.5 kgs)

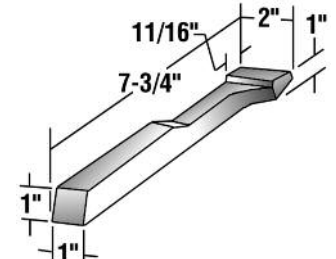

Part No.	Weight
08-751U-1	1.25 lbs (0.6 kgs)

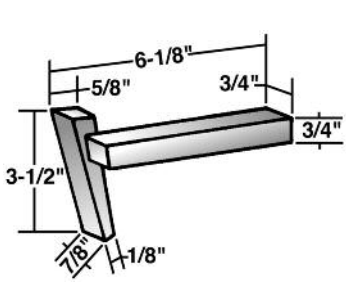

Part No.	Weight
08-7522-1	1.25 lbs (0.6 kgs)

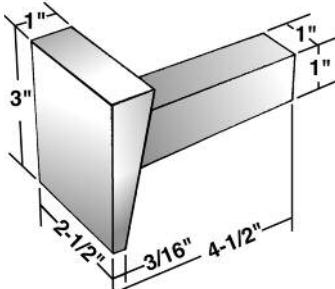

Part No.	Weight
08-7523	2.4 lbs (1.1 kgs)

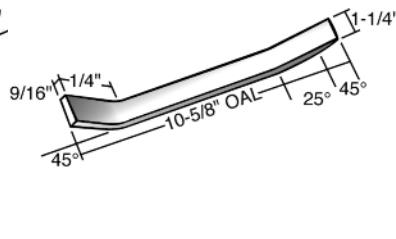

Part No.	Weight
08-7524	2.4 lbs (1.1 kgs)

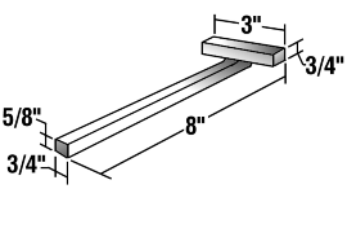

Part No.	Weight
08-753	1.75 lbs (0.8 kgs)

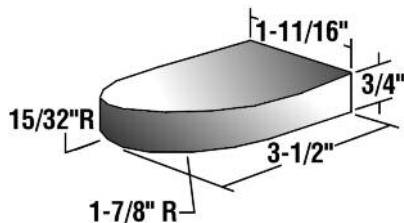

Part No.	Weight
08-753T-4	1.25 lbs (0.6 kgs)

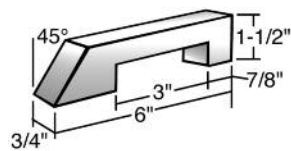

Part No.	Weight
08-760B-2	1.0 lbs (0.45 kgs)

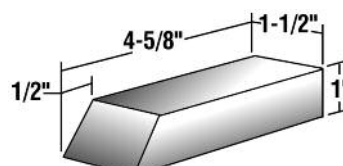

Part No.	Weight
08-760B-10	2.0 lbs (0.9 kgs)

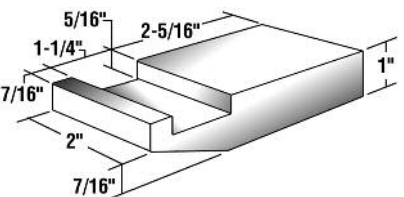

Part No.	Weight
08-78-24C	2.0 lbs (0.9 kgs)

Selection continues on next page...

USATCO U.S. Air Tool Company, Inc.

Eastern Division60 Fleetwood Ct., Ronkonkoma, NY 11779-6907 tel: (631) 471-3300 fax: (631) 471-3308
 Western Division1219 W. Mahalo Place, Rancho Dominguez, CA 90220-5446 tel: (310) 632-5400 fax: (310) 632-3900

USATCO Precision Cast Bucking Bars

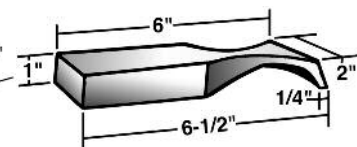
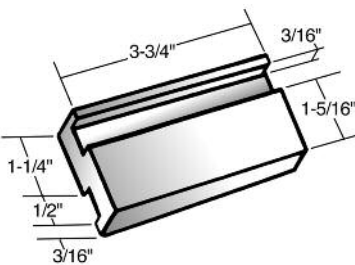
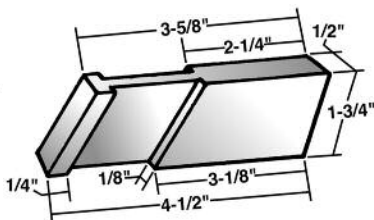
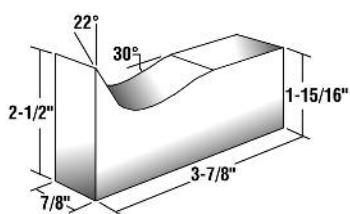

Part No.	Weight
08-83	1.5 lbs (0.7 kgs)

Part No.	Weight
08-860	0.9 lbs (0.4 kgs)

Part No.	Weight
08-861	0.9 lbs (0.4 kgs)

Part No.	Weight
08-862	2.7 lbs (1.2 kgs)

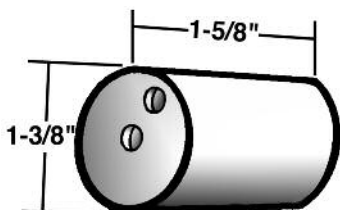

Part No.	Weight
08-864	0.6 lbs (0.3 kgs)

USATCO U.S. Air Tool Company, Inc.

Eastern Division60 Fleetwood Ct., Ronkonkoma, NY 11779-6907 tel: (631) 471-3300 fax: (631) 471-3308

Western Division1219 W. Mahalo Place, Rancho Dominguez, CA 90220-5446 tel: (310) 632-5400 fax: (310) 632-3900